

Data Sheet

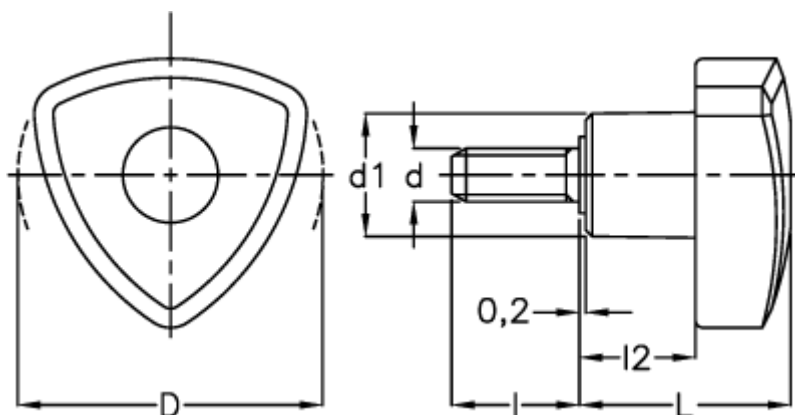

Article number: 2302084253
Description: E+G Lock knob
VTR.60 p-M12x50

Measures



d = 60
d1 = 22
d 6g = M12
l = 50
L = 41
l2 = 22